

## GENERAL DATASHEET VARIABLE SPEED DRIVE

SERIES		MODEL#		
<b>F510</b>		<b>F510-4050-C3-UE</b>		
ISSUED		ENCLOSURE/ FRAME		
<b>12/31/2019</b>		<b>NEMA 1 (IP20) / F5</b>		
INPUT AMPS		AC INPUT VOLTAGE	AC INPUT FREQUENCY	AC INPUT PHASE
ND (VT)				
<b>75</b>		<b>380-480</b>	<b>50/60</b>	<b>3</b>
OUTPUT HP	OUTPUT AMPS	AC OUTPUT VOLTAGE	AC OUTPUT FREQUENCY	AC OUTPUT PHASE
ND (VT)	ND (VT)			
<b>50</b>	<b>72</b>	<b>0-480</b>	<b>0-400</b>	<b>3</b>

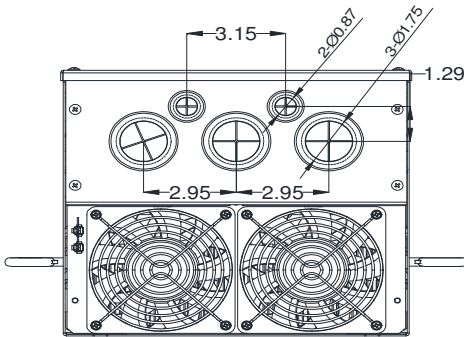
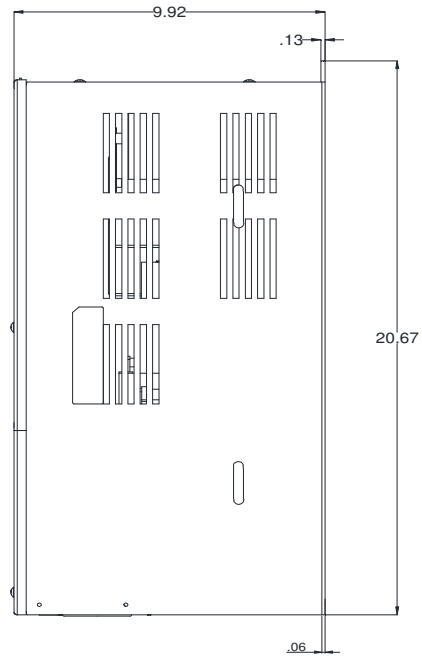
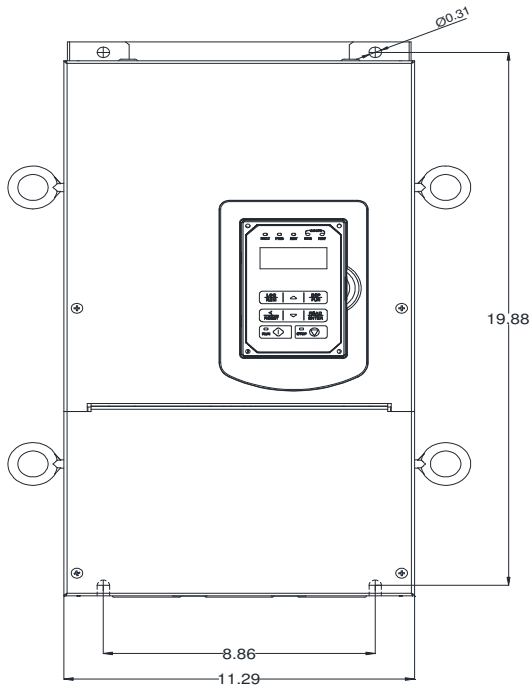

Approved By:	Brian Smith	Drawing No:	F510-460-050-F5	Revision: 1
--------------	-------------	-------------	-----------------	-------------