

GENERAL DATASHEET VARIABLE SPEED DRIVE

Series E510		MODEL# E510-405-H3-U		
ISSUED 8/29/2017		ENCLOSURE/ FRAME NEMA 1 (IP20) / F2		
THREE PHASE INPUT AMPS HD (CT) 11.6		AC INPUT VOLTAGE 380-480	AC INPUT FREQUENCY 50/60	AC INPUT PHASE 3
OUTPUT HP HD (CT) 5	OUTPUT AMPS HD (CT) 9.2	AC OUTPUT VOLTAGE 0-480	AC OUTPUT FREQUENCY 0-599	AC OUTPUT PHASE 3

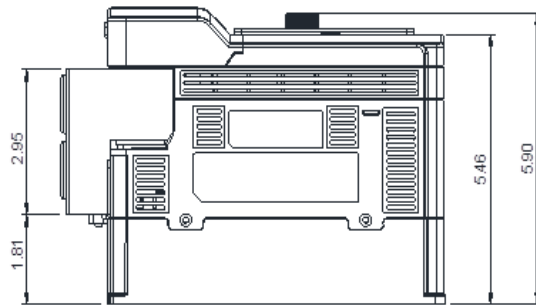
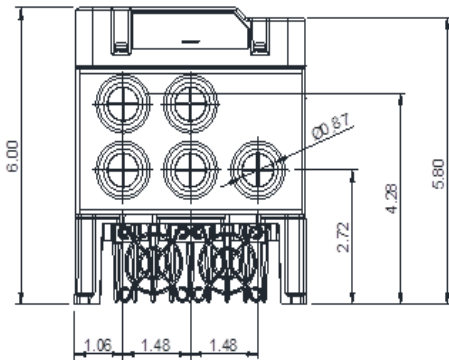
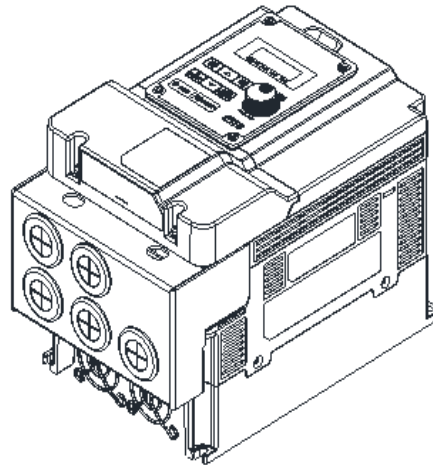
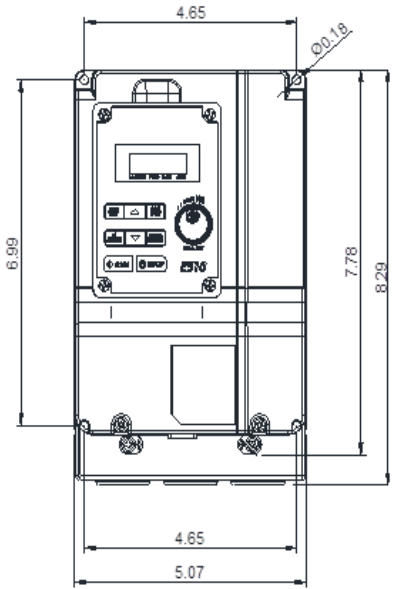

Approved By:	Brian Smith	Drawing No:	E510-460-405-F2	Revision: 0
--------------	-------------	-------------	-----------------	-------------