

GENERAL DATASHEET VARIABLE SPEED DRIVE

Series L510		MODEL# L510-2P5-H3-U	
ISSUED 7/27/2017		ENCLOSURE/ FRAME Chassis (IP20/00)/ F2	
INPUT AMPS HD (CT) 4		AC INPUT VOLTAGE 230	AC INPUT FREQUENCY 50/60
AC INPUT PHASE 3	OUTPUT HP HD (CT) 0.5	AC OUTPUT VOLTAGE 0-230	AC OUTPUT FREQUENCY 0-599
OUTPUT AMPS HD (CT) 2.6	AC OUTPUT PHASE 3		

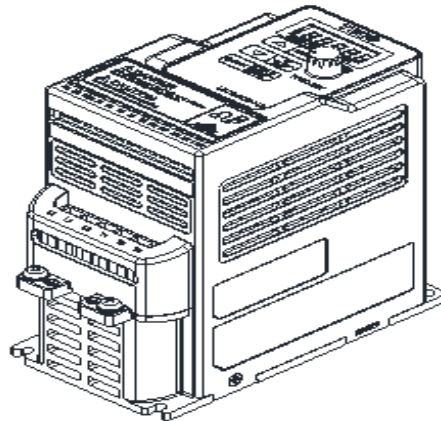
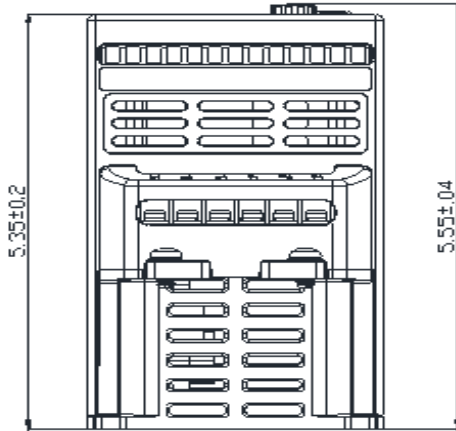
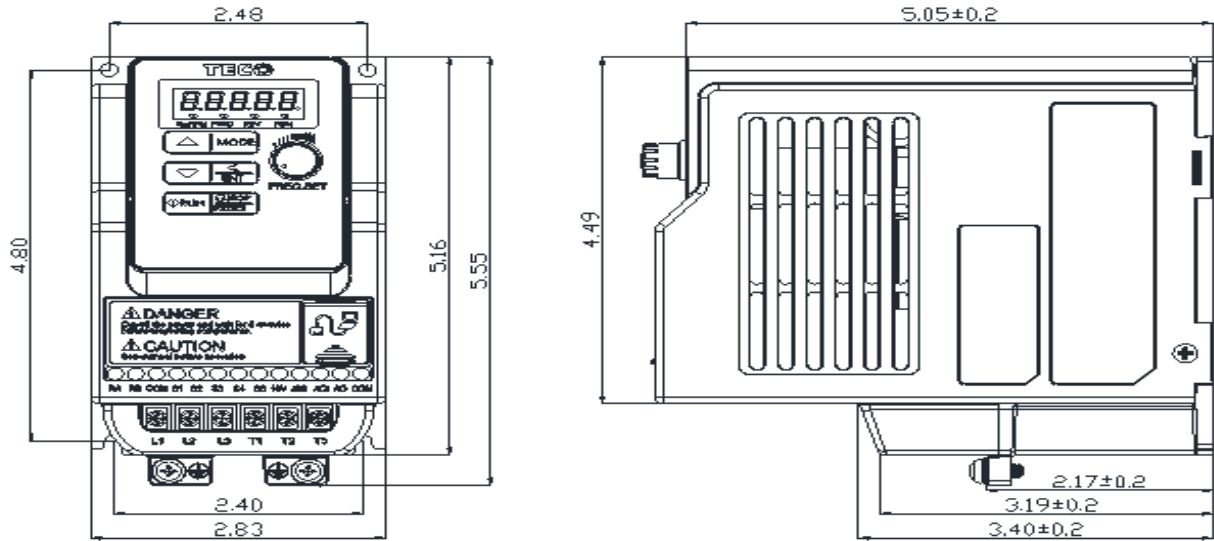

Approved By:	Brian Smith	Drawing No:	L510-230-2P5-F1	Revision: 0
--------------	-------------	-------------	-----------------	-------------